



210
l/min

555
USGPM



15
bar

218
P.S.I.

POLY 2210

55.6000.97.3 - VD
55.6002.97.3 - VM
55.9015.97.3 - VC
556016.97.3 - VC2

Pompa a 5 membrane-pistone semidrauliche.
Pompe à 5 piston-membranes semi-hydrauliques.
Bomba de 5 membranas-pistón semi-hidráulicas

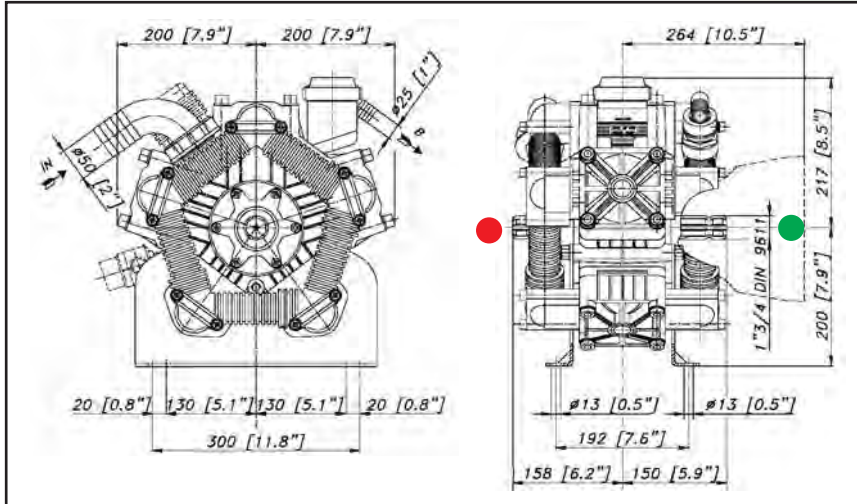

| Caratteristiche tecniche Caractéristiques techniques Características técnicas | | Mod. POLY 2210 | |
|---|-------|--|------------|
| g/min; t/min; rev./min. | g/min | R.P.M. | 550 550 |
| Potenza - Puissance - Potencia | KW | HP | 6 8 |
| Peso - Poids - Peso | kg | lb | 33 72,6 |
| Dislivello aspirazione Pression négative Presión negativa | MAX | M | ft 1,5 4,9 |
| | | Servizio discontinuo Emploi discontinu Servicio discontinuo | mt |
| Ø Aspirazione - Aspiration - Aspiración | mm | in | 50 2" |
| Ø Mandata - Refoulement - Presión | mm | in | 25 1" |
| Max. Temperatura - Température - Temperatura | °C | °F | 60 140 |
| Tipo olio - Type huile - Tipo aceite | SAE | W | 30 30 |
| Capacità olio - Capacité huile - Capacidad aceite | lt | U.S.G. | 3,25 0,85 |

Optional Option Opcional

TABELLA RENDIMENTI - TABLEAU DES PERFORMANCES TABLA DE RENDIMIENTOS

| POLY 2210 | g./min. - t/min. - rev./min. | | | | | | | | |
|--------------|------------------------------|-----------------|------------|-----------------|------------|-----------------|------------|-----------------|------------|
| | 400 | | 450 | | 500 | | 550 | | |
| BAR | P.S.I. | L/min. USGPM | Kw HP | L/min. USGPM | Kw HP | L/min. USGPM | Kw HP | L/min. USGPM | Kw HP |
| 2 | 29 | 153 40,4 | 0,6 0,8 | 172 45,4 | 0,7 0,9 | 191 50,4 | 0,7 1,0 | 210 55,5 | 0,8 1,1 |
| 5 | 72,5 | 151 40,0 | 1,5 2,0 | 170 45,5 | 1,7 2,2 | 189 50,0 | 1,9 2,5 | 208 55,0 | 2,0 2,7 |
| 10 | 145 | 150 39,6 | 2,9 3,9 | 169 44,5 | 3,3 4,4 | 187 49,5 | 3,7 4,9 | 206 54,4 | 4,0 5,4 |
| 15 | 218 | 148 39,2 | 4,4 5,8 | 167 44,1 | 4,9 6,6 | 185 49,0 | 5,5 7,3 | 204 53,9 | 6,0 8,0 |

ALBERO POMPA - ARBRE POMPE - CIGÜEÑAL BOMBA



● ANT. - AVANT - ANTERIOR



● ANT. - AVANT - ANTERIOR



● POST. - ARRIÈRE
POSTERIOR



● POST. - ARRIÈRE
POSTERIOR

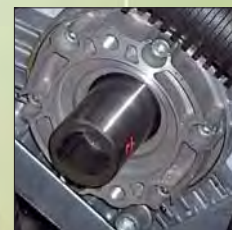

● POST. - ARRIÈRE
POSTERIOR

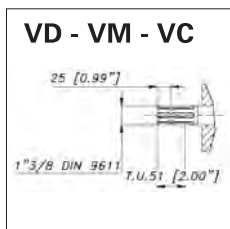

VD - VM - VC

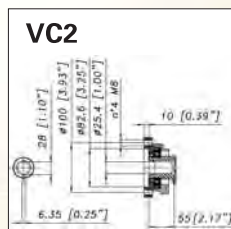

VC2

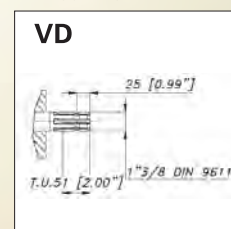

VD

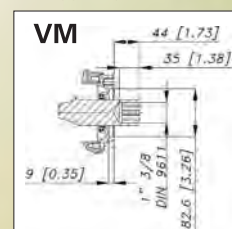

VM

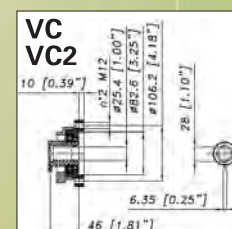

VC
VC2